

Valves, Fittings and Tubing for Sour Gas Applications

» Pressures to 30,000 psi (2,070 bar)



MAXIMATOR has been designing and manufacturing high pressure equipment for more than thirty years and has a worldwide reputation for quality and reliability, backed by one of the best service organizations in the industry.

Oil & Gas Products feature:

- Rising stem design, both solid and 2piece configuration are available.
- All pressure-containing materials comply with the requirements of NACE MRO175.
- Annealed 316 L (1.4404) wetted parts and 17-4 PH Stem (or N05500 for one piece stem) for excellent corrosion resistance.
- Metal-to-metal seating achieves bubble-tight shut-off, longer stem and seat life, greater durability for repeated open and close cycles.
- PTFE and carbon packing with metal back-up rings offers reliable stem to body sealing.
- Safety weep holes for all pressure connections and packing area.
- Six different valve body patterns, with choice of vee or regulating type stem tip.

MAXIMATOR offers a complete line of high pressure valves, fittings, tubing, check valves and line filters for standard oil field service where H₂S is present. All high pressure valves and fittings use the high pressure style connection.

Note: When selecting multiple items, the pressure rating would be that of the lowest rated component.



Index	Page:
Valves rated to 22,500 psi (1,550 bar)	2 – 3
Valves rated to 30,000 psi (2,070 bar)	4 – 5
Fittings	6 – 7
Check Valves	8
Line Filters	9
Sour Gas Adapters and Couplings	10 – 13
Tubing	14
Coned and Threaded Nipples	15

MAXIMATOR GmbH, Lange Straße 6, 99734 Nordhausen, Telefon +49 (0) 3631 9533-0, Telefax +49 (0) 3631 9533-5010, www.maximator.de, info@maximator.de
All technical and dimensional information subject to change. All general Terms and Conditions of sale, including limitations of our liability, apply to all products and services sold.

Products for Sour Gas Applications
Pipe Valves & Fittings
to 15,200 psi (1,050 bar)

Adapters and Couplings
Medium Pressure
to 22,500 psi (1,550 bar)

Accessories
High Pressure
to 65,000 psi (4,500 bar)

Tools
Ultra High Pressure
to 152,000 psi (10,500 bar)

Technical Information
Valve Actuators

Customized Solutions
Ball Valves
to 21,000 psi (1,500 bar)

High Pressure Valves for Sour Gas Applications

» Pressures to 22,500 psi (1,550 bar)



Sour Gas Valves

Maximator Sour Gas Valves are designed for oil and gas service where H₂S is present. All pressure containing components are made from annealed 316 stainless steel material in compliance with NACE MR0175. These needle valves with metal to metal seats have a high level of safety and reliability under harsh operating conditions. These valves may be used both with gases and liquids.

Traceability is ensured through extensively documented data (batch number, maximum pressure, material number, type designation). All Sour Gas components are supplied with collars and glands unless otherwise specified.

Ordering Information
Typical catalog number:
22V4H071-S0G

22 V Valve Series	4H O.D. Tube Size	07 Stem Type	1 Body Pattern	SOG-Sour Gas
22 V	4H – 1/4"	00 – One piece rotating Vee stem	1 – two-way straight	SOGWO–
	6H – 3/8"	01 – One piece rotating Regulating stem	2 – two-way angle	Sour Gas
	9H – 9/16"	07 – non rotating Vee stem (on-off service)	3 – three-way, two on pressure	without
		08 – non rotating Regulating stem (tapered tip for regulating and shut-off)	4 – three-way, one on pressure	Glands &
		80 – One piece Vee stem with replaceable seat	5 – three-way, two-stem manifold	Collars
		81 – One piece Regulating stem with replaceable seat		

O.D. Size in. (mm)	Connec- tion Type	Orifice Size in. (mm)	Rated Cv*	Pressure Rating @ R.T. psi (bar)**
1/4 (6.35)	4HF	0.094 (2.3)	0.12	22,500 (1,550)
3/8 (9.53)	6HF	0.125 (3.2)	0.23	22,500 (1,550)
9/16 (14.30)	9HF	0.125 (3.2)	0.33	22,500 (1,550)

* Cv values shown are for 2-way straight pattern vee stem valves. For 2-way angle patterns, increase the Cv value by 50%.

** See page 2 in the Technical Section for Pressure/Temperature Rating Chart.

Consult your MAXIMATOR representative for **repair kits** and valve bodies. Refer to the Tools and Installation section for proper maintenance procedures.

Products for Sour Gas Applications
Pipe Valves & Fittings
to 15,200 psi (1,050 bar)

Adapters and Couplings
Medium Pressure
to 22,500 psi (1,550 bar)

Accessories
High Pressure
to 65,000 psi (4,500 bar)

Tools
Ultra High Pressure
to 152,000 psi (10,500 bar)

Technical Information
Valve Actuators

Customized Solutions
Ball Valves
to 21,000 psi (1,500 bar)

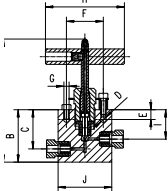
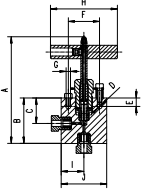
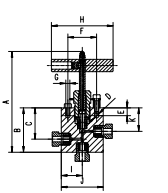
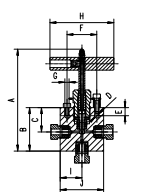
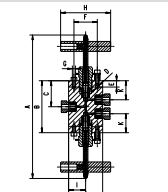
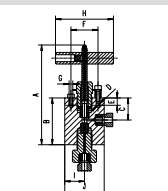
Valve Pattern	Catalog Number	Stem Type	O.D. Tube in.	Orifice in. (mm)	Dimensions in. (mm)										Valve Panel Hole	Block Thickness
					A	B	C	D	E	F	H	I	J	K		
2-Way Straight																
	22V4H001-SOG	Vee	1/4	0.094	4.96	2.01	1.50	0.22	0.37	1.38	2.95	1.12	2.01		1.00	1.02
	22V4H081-SOG	Reg		(2.3)	(126)	(51)	(38)	(5.6)	(9.5)	(35)	(75)	(28.5)	(51)		(25.4)	(25.9)
	22V6H001-SOG	Vee	3/8	0.125	4.96	2.01	1.50	0.22	0.37	1.38	2.95	1.12	2.01		1.00	1.02
	22V6H081-SOG	Reg		(3.2)	(126)	(51)	(38)	(5.6)	(9.5)	(35)	(75)	(28.5)	(51)		(25.4)	(25.9)
	22V9H001-SOG	Vee	9/16	0.125	5.00	2.44	1.56	0.22	0.37	1.38	2.95	1.12	2.64		1.00	1.54
	22V9H001-SOG	Reg		(3.2)	(127)	(62)	(39.6)	(5.6)	(9.5)	(35)	(75)	(28.5)	(57)		(25.4)	(39.1)
2-Way Angle																
	22V4H002-SOG	Vee	1/4	0.094	4.96	2.01	1.12	0.22	0.37	1.38	2.95	1.00	2.01		1.00	1.02
	22V4H082-SOG	Reg		(2.3)	(126)	(51)	(28.5)	(5.6)	(9.5)	(35)	(75)	(25.4)	(51)		(25.4)	(25.9)
	22V6H002-SOG	Vee	3/8	0.125	4.78	2.20	1.10	0.22	0.37	1.38	2.95	1.00	2.01		1.00	1.02
	22V6H082-SOG	Reg		(3.2)	(121.5)	(56)	(28)	(5.6)	(9.5)	(35)	(75)	(25.4)	(51)		(25.4)	(25.9)
	22V9H002-SOG	Vee	9/16	0.125	5.00	2.44	1.12	0.22	0.37	1.38	2.95	1.32	2.64		1.00	1.54
	22V9H082-SOG	Reg		(3.2)	(127)	(62)	(28.5)	(5.6)	(9.5)	(35)	(75)	(33.5)	(57)		(25.4)	(39.1)
3-Way / 2 on Pressure																
	22V4H003-SOG	Vee	1/4	0.094	4.96	2.13	1.50	0.22	0.37	1.38	2.95	1.00	2.01	1.12	1.00	1.02
	22V4H083-SOG	Reg		(2.3)	(119.1)	(54.1)	(38)	(5.6)	(9.5)	(35)	(75)	(25.4)	(51)	(28.5)	(25.4)	(25.9)
	22V6H003-SOG	Vee	3/8	0.125	5.08	2.50	1.50	0.22	0.37	1.38	2.95	1.00	2.01	1.12	1.00	1.02
	22V6H083-SOG	Reg		(3.2)	(129)	(63.5)	(38)	(5.6)	(9.5)	(35)	(75)	(25.4)	(51)	(28.5)	(25.4)	(25.9)
	22V9H003-SOG	Vee	9/16	0.125	5.45	2.87	1.56	0.22	0.37	1.38	2.95	1.32	2.64	1.12	1.00	1.54
	22V9H083-SOG	Reg		(3.2)	(138.5)	(72.9)	(39.5)	(5.6)	(9.5)	(35)	(75)	(33.5)	(67)	(28.5)	(25.4)	(39.1)
3-Way / 1 on Pressure																
	22V4H004-SOG	Vee	1/4	0.094	4.96	2.01	1.12	0.22	0.37	1.38	2.95	1.00	2.01		1.00	1.02
	22V4H084-SOG	Reg		(2.3)	(126)	(51)	(28.5)	(5.6)	(9.5)	(35)	(75)	(25.4)	(51)		(25.4)	(25.9)
	22V6H004-SOG	Vee	3/8	0.125	4.76	2.20	1.12	0.22	0.37	1.38	2.95	1.00	2.01		1.00	1.02
	22V6H084-SOG	Reg		(3.2)	(121)	(56)	(28.5)	(5.6)	(9.5)	(35)	(75)	(25.4)	(51)		(25.4)	(25.9)
	22V9H004-SOG	Vee	9/16	0.125	5.00	2.44	1.12	0.22	0.37	1.38	2.95	1.32	2.64		1.00	1.54
	22V9H084-SOG	Reg		(3.2)	(127)	(62)	(28.5)	(5.6)	(9.5)	(35)	(75)	(33.5)	(67)		(25.4)	(39.1)
3-Way / 2-Stem Manifold																
	22V4H005-SOG	Vee	1/4	0.094	8.23	3.07	1.54	0.22	0.37	1.38	2.95	1.00	2.01	1.12	1.00	1.02
	22V4H085-SOG	Reg		(2.3)	(209)	(78)	(39.1)	(5.6)	(9.5)	(35)	(75)	(25.4)	(51)	(28.5)	(25.4)	(25.9)
	22V6H005-SOG	Vee	3/8	0.125	8.39	3.25	1.61	0.22	0.37	1.38	2.95	1.00	2.01	1.12	1.00	1.02
	22V6H085-SOG	Reg		(3.2)	(213)	(82.5)	(40.9)	(5.6)	(9.5)	(35)	(75)	(25.4)	(51)	(28.5)	(25.4)	(25.9)
	22V9H005-SOG	Vee	9/16	0.125	8.90	3.74	1.88	0.22	0.37	1.38	2.95	1.32	2.64	1.12	1.00	1.54
	22V9H085-SOG	Reg		(3.2)	(226)	(95)	(47.8)	(5.6)	(9.5)	(35)	(75)	(33.5)	(67)	(28.5)	(25.4)	(39.1)
2-Way Angle / Replaceable Seat																
	22V4H802-SOG	Vee	1/4	0.094	4.96	2.38	1.12	0.22	0.37	1.38	2.95	1.00	2.01		1.00	1.02
	22V4H882-SOG	Reg		(2.3)	(126)	(60.5)	(28.5)	(5.6)	(9.5)	(35)	(75)	(25.4)	(51)		(25.4)	(25.9)
	22V6H802-SOG	Vee	3/8	0.125	4.96	2.38	1.12	0.22	0.37	1.38	2.95	1.00	2.01		1.00	1.02
	22V6H882-SOG	Reg		(3.2)	(126)	(60.5)	(28.5)	(5.6)	(9.5)	(35)	(75)	(25.4)	(51)		(25.4)	(25.9)
	22V9H802-SOG	Vee	9/16	0.125	5.00	2.44	1.18	0.22	0.37	1.38	2.95	1.32	2.64		1.00	1.54
	22V9H882-SOG	Reg		(3.2)	(127)	(62)	(30)	(5.6)	(9.5)	(35)	(75)	(33.5)	(57)		(25.4)	(39.1)

G - Panel mounting screw thread size 10-24 UNC (screw included). All dimensions are for reference only and are subject to change.

All technical and dimensional information subject to change. All general Terms and Conditions of sale, including limitations of our liability, apply to all products and services sold.

High Pressure Valves for Sour Gas Applications

» Pressures to 30,000 psi (2,070 bar)



Sour Gas Valves

Maximator Sour Gas Valves are designed for oil and gas service where H₂S is present. All pressure containing components are made from annealed 316 stainless steel material in compliance with NACE MR0175. These needle valves with metal to metal seats have a high level of safety and reliability under harsh operating conditions. These valves may be used both with gases and liquids.

Traceability is ensured through extensively documented data (batch number, maximum pressure, material number, type designation). All Sour Gas components are supplied with collars and glands unless otherwise specified.

Ordering Information
Typical catalog number:
30V4H071-SOG

30 V Valve Series	4H O.D. Tube Size	07 Stem Type	1 Body Pattern	SOG-Sour Gas	
30 V	4H – 1/4"	00 – One piece rotating Vee stem	1 – two-way straight	SOGWO–	
	6H – 3/8"	01 – One piece rotating Regulating stem	2 – two-way angle	Sour Gas	
	9H – 9/16"		07 – non rotating Vee stem (on-off service)	3 – three-way, two on pressure	without
			08 – non rotating Regulating stem (tapered tip for regulating and shut-off)	4 – three-way, one on pressure	Glands &
			80 – One piece Vee stem with replaceable seat	5 – three-way, two-stem manifold	Collars
			81 – One piece Regulating stem with replaceable seat		

O.D. Size in. (mm)	Connec- tion Type	Orifice Size in. (mm)	Rated Cv*	Pressure Rating @ R.T. psi (bar)**
1/4 (6.35)	4HF	0.062 (1.6)	0.08	30,000 (2,070)
3/8 (9.53)	6HF	0.062 (1.6)	0.09	30,000 (2,070)
9/16 (14.30)	9HF	0.078 (2.0)	0.14	30,000 (2,070)

* Cv values shown are for 2-way straight pattern vee stem valves. For 2-way angle patterns, increase the Cv value by 50%.

** See page 2 in the Technical Section for Pressure/Temperature Rating Chart.

Consult your MAXIMATOR representative for **repair kits** and valve bodies. Refer to the Tools and Installation section for proper maintenance procedures.

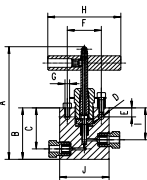
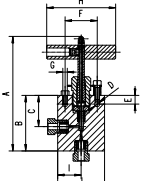
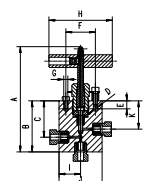
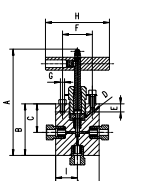
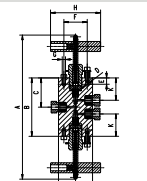
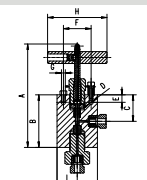
Valve Pattern	Catalog Number	Stem Type	O.D. Tube in.	Orifice in. (mm)	Dimensions in. (mm)										Valve Panel Hole	Block Thickness
					A	B	C	D	E	F	H	I	J	K		
2-Way Straight																
	30V4H001-SOG	Vee	1/4	0.062	4.67	2.13	1.96	0.22	0.37	1.38	2.95	1.32	2.01		1.00	1.02
	30V4H081-SOG	Reg		(1.6)	(118.6)	(54.1)	(43)	(5.6)	(9.5)	(35)	(75)	(33.5)	(51)		(25.4)	(25.9)
	30V6H001-SOG	Vee	3/8	0.062	4.80	2.24	1.96	0.22	0.37	1.38	2.95	1.32	2.01		1.00	1.02
	30V6H081-SOG	Reg		(1.6)	(122)	(56.9)	(43)	(5.6)	(9.5)	(35)	(75)	(33.5)	(51)		(25.4)	(25.9)
	30V9H001-SOG	Vee	9/16	0.078	5.04	2.50	1.75	0.22	0.37	1.38	2.95	1.30	2.64		1.00	1.54
	30V9H081-SOG	Reg		(2)	(128)	(63.5)	(44.5)	(5.6)	(9.5)	(35)	(75)	(33)	(57)		(25.4)	(39.1)
2-Way Angle																
	30V4H002-SOG	Vee	1/4	0.062	4.96	2.38	1.34	0.22	0.37	1.38	2.95	1.00	2.01		1.00	1.02
	30V4H082-SOG	Reg		(1.6)	(126)	(60.5)	(34)	(5.6)	(9.5)	(35)	(75)	(25.4)	(51)		(25.4)	(25.9)
	30V6H002-SOG	Vee	3/8	0.062	5.16	2.62	1.32	0.22	0.37	1.38	2.95	1.00	2.01		1.00	1.02
	30V6H082-SOG	Reg		(1.6)	(131)	(66.5)	(33.5)	(5.6)	(9.5)	(35)	(75)	(25.4)	(51)		(25.4)	(25.9)
	30V9H002-SOG	Vee	9/16	0.078	5.35	2.80	1.32	0.22	0.37	1.38	2.95	1.32	2.64		1.00	1.54
	30V9H082-SOG	Reg		(2)	(136)	(71.1)	(33.5)	(5.6)	(9.5)	(35)	(75)	(33.5)	(57)		(25.4)	(39.1)
3-Way / 2 on Pressure																
	30V4H003-SOG	Vee	1/4	0.062	4.96	2.38	1.69	0.22	0.37	1.38	2.95	1.00	2.01	1.32	1.00	1.02
	30V4H083-SOG	Reg		(1.6)	(126)	(60.5)	(43)	(5.6)	(9.5)	(35)	(75)	(25.4)	(51)	(33.5)	(25.4)	(25.9)
	30V6H003-SOG	Vee	3/8	0.062	5.31	2.76	1.69	0.22	0.37	1.38	2.95	1.00	2.01	1.32	1.00	1.02
	30V6H083-SOG	Reg		(1.6)	(134.9)	(70.1)	(43)	(5.6)	(9.5)	(35)	(75)	(25.4)	(51)	(33.5)	(25.4)	(25.9)
	30V9H003-SOG	Vee	9/16	0.078	5.71	3.15	1.75	0.22	0.37	1.38	2.95	1.32	2.64	1.30	1.00	1.54
	30V9H083-SOG	Reg		(2)	(145)	(80)	(44.5)	(5.6)	(9.5)	(35)	(75)	(33.5)	(67)	(33)	(25.4)	(39.1)
3-Way / 1 on Pressure																
	30V4H004-SOG	Vee	1/4	0.062	4.96	2.38	1.32	0.22	0.37	1.38	2.95	1.00	2.01		1.00	1.02
	30V4H084-SOG	Reg		(1.6)	(126)	(60.5)	(33.5)	(5.6)	(9.5)	(35)	(75)	(25.4)	(51)		(25.4)	(25.9)
	30V6H004-SOG	Vee	3/8	0.062	5.16	2.62	1.32	0.22	0.37	1.38	2.95	1.00	2.01		1.00	1.02
	30V6H084-SOG	Reg		(1.6)	(131)	(66.5)	(33.5)	(5.6)	(9.5)	(35)	(75)	(25.4)	(51)		(25.4)	(25.9)
	30V9H004-SOG	Vee	9/16	0.078	5.35	2.80	1.32	0.22	0.37	1.38	2.95	1.32	2.64		1.00	1.54
	30V9H084-SOG	Reg		(2)	(136)	(71.1)	(33.5)	(5.6)	(9.5)	(35)	(75)	(33.5)	(67)		(25.4)	(39.1)
3-Way / 2-Stem Manifold																
	30V4H005-SOG	Vee	1/4	0.062	8.56	3.44	1.72	0.22	0.37	1.38	2.95	1.00	2.01	1.32	1.00	1.02
	30V4H085-SOG	Reg		(1.6)	(217.4)	(87.4)	(43.7)	(5.6)	(9.5)	(35)	(75)	(25.4)	(51)	(33.5)	(25.4)	(25.9)
	30V6H005-SOG	Vee	3/8	0.062	8.56	3.76	1.89	0.22	0.37	1.38	2.95	1.00	2.01	1.32	1.00	1.02
	30V6H085-SOG	Reg		(1.6)	(217.4)	(95.5)	(48)	(5.6)	(9.5)	(35)	(75)	(25.4)	(51)	(33.5)	(25.4)	(25.9)
	30V9H005-SOG	Vee	9/16	0.078	9.25	4.13	2.07	0.22	0.37	1.38	2.95	1.32	2.64	1.30	1.00	1.54
	30V9H085-SOG	Reg		(2)	(235)	(105)	(52.6)	(5.6)	(9.5)	(35)	(75)	(33.5)	(67)	(33)	(25.4)	(39.1)
2-Way Angle / Replaceable Seat																
	30V4H802-SOG	Vee	1/4	0.062	5.16	2.62	1.32	0.22	0.37	1.38	2.95	1.00	2.01		1.00	1.02
	30V4H882-SOG	Reg		(1.6)	(131)	(66.5)	(33.5)	(5.6)	(9.5)	(35)	(75)	(25.4)	(51)		(25.4)	(25.9)
	30V6H802-SOG	Vee	3/8	0.062	5.16	2.62	1.32	0.22	0.37	1.38	2.95	1.00	2.01		1.00	1.02
	30V6H882-SOG	Reg		(1.6)	(131)	(66.5)	(33.5)	(5.6)	(9.5)	(35)	(75)	(25.4)	(51)		(25.4)	(25.9)
	30V9H802-SOG	Vee	9/16	0.078	5.16	2.62	1.32	0.22	0.37	1.38	2.95	1.32	2.64		1.00	1.54
	30V9H882-SOG	Reg		(2)	(131)	(66.5)	(33.5)	(5.6)	(9.5)	(35)	(75)	(33.5)	(57)		(25.4)	(39.1)

G - Panel mounting screw thread size 10-24 UNC (screw included). All dimensions are for reference only and are subject to change.

All technical and dimensional information subject to change. All general Terms and Conditions of sale, including limitations of our liability, apply to all products and services sold.

High Pressure Fittings for Sour Gas Applications

» Pressures to 30,000 psi (2,070 bar)

Sour Gas Fittings

Maximator Sour Gas Fittings are designed for oil and gas services where H₂S is present. All pressure containing components are made from annealed 316 stainless steel material in compliance with NACE MR0175. All High Pressure fittings are supplied with collars and glands. Mounting holes are standard on all elbows, tees, and crosses.



Tubing Size	Gland	Collar	Plug	Tubing Cap
1/4	30G4H-SOG	30C4H-SOG	30P4H-SOG	30TC4H-SOG
3/8	30G6H-SOG	30C6H-SOG	30P6H-SOG	30TC6H-SOG
9/16	30G9H-SOG	30C9H-SOG	30P9H-SOG	30TC9H-SOG

Connection Components

All high pressure fittings are supplied with glands and collars. Refer to the adjacent chart for ordering any of the connection components individually. When using the plug, the collar is not needed.

Fitting Pattern	Catalog Number	Connection Type	O.D. Tube Size in.	Orifice in. (mm)	Dimensions in. (mm)							Block Thickness
					A	B	C	D	E	F	G	
Elbow												
	30L4H-SOG	4HF	1/4	0.094 (2.3)	0.89 (22.6)	1.02 (25.9)	1.54 (39.1)	0.63 (16)	0.46 (11.7)	0.65 (16.5)	0.22 (5.6)	1.02 (25.9)
	30L6H-SOG	6HF	3/8	0.125 (3.2)	1.26 (32)	1.50 (38.1)	2.01 (51)	0.98 (24.9)	0.72 (18.3)	0.69 (17.5)	0.26 (6.6)	1.02 (25.9)
	30L9H-SOG	9HF	9/16	0.188 (4.8)	1.89 (48)	1.89 (48)	2.64 (67)	1.10 (28)	0.83 (21.1)	0.94 (23.9)	0.33 (8.4)	1.54 (39.1)
Tee												
	30T4H-SOG	4HF	1/4	0.094 (2.3)	1.00 (25.4)	1.26 (32)	2.01 (51)	0.89 (22.6)	0.46 (11.7)	1.30 (33)	0.22 (5.6)	1.02 (25.9)
	30T6H-SOG	6HF	3/8	0.125 (3.2)	1.00 (25.4)	1.57 (39.9)	2.01 (51)	1.06 (26.9)	0.72 (18.3)	1.38 (35)	0.26 (6.6)	1.02 (25.9)
	30T9H-SOG	9HF	9/16	0.188 (4.8)	1.32 (33.5)	2.13 (54.1)	2.64 (67)	1.38 (35)	0.83 (21.1)	1.89 (48)	0.33 (8.4)	1.54 (39.1)

See page 2 in the Technical Section for pressure/temperature rating chart. All dimensions are for reference only and are subject to change.

Products for Sour Gas Applications
Pipe Valves & Fittings
to 15,200 psi (1,050 bar)

Adapters and Couplings
Medium Pressure
to 22,500 psi (1,550 bar)

Accessories
High Pressure
to 65,000 psi (4,500 bar)

Tools
Ultra High Pressure
to 152,000 psi (10,500 bar)

Technical Information
Valve Actuators

Customized Solutions
Ball Valves
to 21,000 psi (1,500 bar)

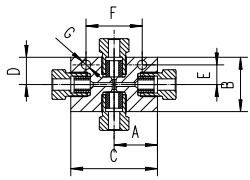
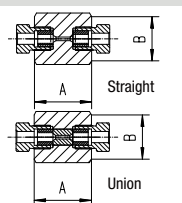
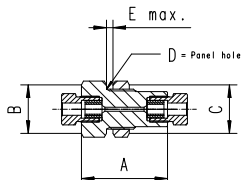
Fitting Pattern	Catalog Number	Connection Type	O.D. Tube Size in.	Orifice in. (mm)	Dimensions in. (mm)							Block Thickness
					A	B	C	D	E	F	G	
Cross												
	30X4H-SOG	4HF	1/4	0.094 (2.3)	1.00 (25.4)	1.26 (32)	2.01 (51.1)	0.63 (16)	0.46 (11.7)	1.30 (33)	0.22 (5.6)	1.02 (25.9)
	30X6H-SOG	6HF	3/8	0.125 (3.2)	1.00 (25.4)	2.13 (54.1)	2.01 (51.1)	1.06 (27)	0.72 (18.3)	1.38 (35)	0.26 (6.6)	1.02 (25.9)
	30X9H-SOG	9HF	9/16	0.188 (4.8)	1.32 (33.5)	2.76 (70.1)	2.64 (67)	1.38 (35)	0.83 (21.1)	1.89 (48)	0.33 (8.4)	1.54 (39.1)
Straight Coupling / Union Coupling												
	30F4H-SOG	4HF	1/4	0.094 (2.3)	1.38 (35)	1.06 (27)	Straight Coupling					
	30UF4H-SOG						Union Coupling					
	30F6H-SOG	6HF	3/8	0.125 (3.2)	1.77 (45)	1.06 (27)	Straight Coupling					
	30UF6H-SOG						Union Coupling					
	30F9H-SOG	9HF	9/16	0.188 (4.8)	2.19 (55.6)	1.44 (36.6)	Straight Coupling					
	30UF9H-SOG						Union Coupling					
Bulkhead Coupling												
	30BF4H-SOG	4HF	1/4	0.094 (2.3)	1.89 (48)	1.06 (27)	1.06 (27)	0.94 (23.9)	0.16 (4)			
	30BF6H-SOG	6HF	3/8	0.125 (3.2)	2.38 (60.5)	1.44 (36.5)	1.44 (36.5)	1.12 (28.5)	0.35 (8.9)			
	30BF9H-SOG	9HF	9/16	0.188 (4.8)	2.76 (70.1)	1.63 (41.3)	1.63 (41.3)	1.43 (36.3)	0.67 (17)			

See page 2 in the Technical Section for pressure/temperature rating chart.
All dimensions are for reference only and are subject to change.

Check Valves for Sour Gas Applications

» Pressures to 30,000 psi (2,070 bar)

O-Ring Check Valves

Maximator o-ring check valves provide high quality directional flow control and bubble tight shut-off for liquids and gases. These check valves are not to be used as a relief device. The opening pressure of the O-Ring Check Valves is approx. 20 psi **(1.5 bar)**.

» **Materials:**

Body, cover, poppet, cover gland: annealed 316 stainless steel

Spring: Inconel X-750

O-ring: FKM "A" [-4°F to 392°F **(-20°C to 200°C)**]

Ball Check Valves

Maximator ball check valves prevent reverse flow where bubble tight shut-off is not mandatory. These check valves are designed to operate to 660°F. These check valves are not to be used as a relief device. The opening pressure of the Ball Check Valves is approx. 20 psi **(1.5 bar)**.

» **Materials:**

Body, cover, poppet, cover gland: annealed 316 series stainless steel

Ball: annealed 316 series stainless steel

Spring: Inconel X-750

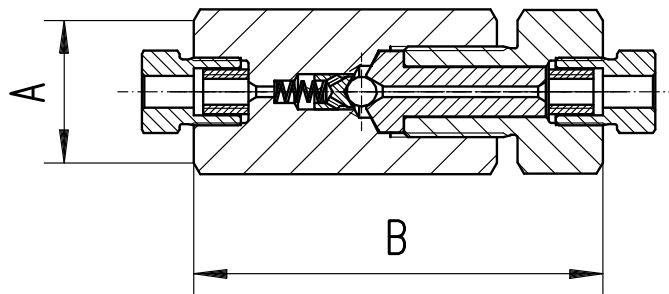
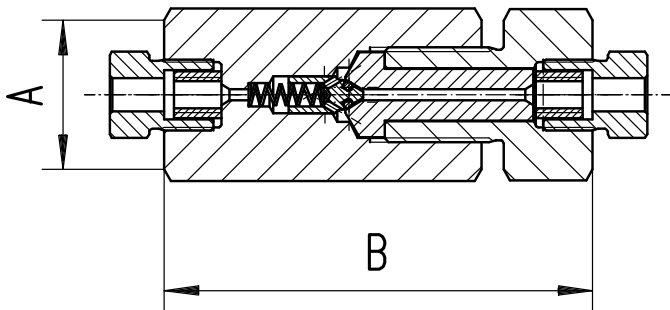

Catalog Number	Connection Type	Pressure Rating psi (bar)	Orifice in. (mm)	Rated (Cv)	Dimensions in. (mm)	
					A (Hex.)	B
O-Ring Check Valves						
300C4H-SOG	4HF	30,000 (2,070)	0.094 (2.3)	0.15	1.19 (30.2)	3.40 (86.4)
300C6H-SOG	6HF	30,000 (2,070)	0.125 (3.2)	0.28	1.19 (30.2)	3.81 (96.8)
300C9H-SOG	9HF	30,000 (2,070)	0.188 (4.8)	0.63	1.63 (41.4)	4.61 (117.1)
Ball Check Valves						
30BC4H-SOG	4HF	30,000 (2,070)	0.094 (2.3)	0.15	1.19 (30.2)	3.40 (86.4)
30BC6H-SOG	6HF	30,000 (2,070)	0.125 (3.2)	0.28	1.19 (30.2)	3.81 (96.8)
30BC9H-SOG	9HF	30,000 (2,070)	0.188 (4.8)	0.63	1.63 (41.4)	4.61 (117.1)

CAUTION: FREQUENT INSPECTIONS OF O-Rings are necessary to ensure proper service of the check valve.

O-Rings have shown satisfactory service life in testing, however different service conditions may lead to variations in cycle and shelf life.

All dimensions are for reference only and subject to change.

All technical and dimensional information subject to change. All general Terms and Conditions of sale, including limitations of our liability, apply to all products and services sold.

Dual-Disc Line Filters

Maximator dual-disc line filters are used to filter process fluids in high pressure systems. This design helps remove the large particles first through a coarse primary disc, which then allows a secondary disc to provide a smaller micron filtration. These filter elements are designed to withstand pressure surges without cracking, flaking, or rupturing. Filter elements come standard in the following micron sizes: 5/8, 8/30, 30/56 (secondary/primary). Filters are rated for temperatures -60°F to 660°F (-50°C to 350°C). All line filters come with glands and collars.

» **Materials:**

Body, cover, cover gland: 316 series stainless steel
Element: 316 series stainless steel

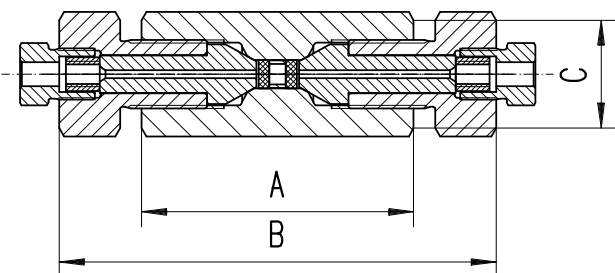

Cup-Type Line Filters

Maximator cup-type line filters are used when maximum filtration surface area and a single micron size element is preferred. This design increases the filter area as much as 6 times the area of the disc type filter, and will permit higher flow rates with a lower pressure drop, and longer intervals between element changes. Filter elements come standard in 5, 30, or 56 micron sizes and are easily replaced. Filters are rated for temperatures -60°F to 660°F (-50°C to 350°C). All line filters come with glands and collars.

» **Materials:**

Body, cover, cover gland: 316 series stainless steel
Element: 316 series stainless steel

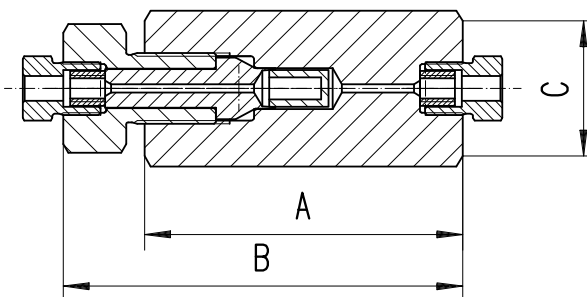

Catalog Number	Pressure Rating psi (bar)	Orifice in. (mm)	Micron Size	Connection Type	Filter Element Area in. ² (mm) ²	Dimensions in. (mm)		
						A	B	C (Hex.)
Dual-Disc Line Filters								
30DF4H-5/8-SOG	30,000 (2,070)	0.094 (2.3)	5/8	4HF	0.07 (50)	2.99 (76)	4.8 (121.9)	1.19 (30.2)
30DF4H-8/30-SOG			8/30					
30DF4H-30/56-SOG			30/56					
30DF6H-5/8-SOG	30,000 (2,070)	0.125 (3.2)	5/8	6HF	0.07 (50)	2.99 (76)	5.29 (134.4)	1.19 (30.2)
30DF6H-8/30-SOG			8/30					
30DF6H-30/56-SOG			30/56					
30DF9H-5/8-SOG	30,000 (2,070)	0.188 (4.8)	5/8	9HF	0.15 (95)	3.39 (86.1)	5.75 (146)	1.44 (36.6)
30DF9H-8/30-SOG			8/30					
30DF9H-30/56-SOG			30/56					
Cup-Type Line Filters								
30CF4H-5-SOG	30,000 (2,070)	0.094 (2.3)	5	4HF	0.82 (530)	3.39 (86.1)	4.25 (108)	1.44 (36.6)
30CF4H-30-SOG			30					
30CF4H-56-SOG			56					
30CF6H-5-SOG	30,000 (2,070)	0.125 (3.2)	5	6HF	0.82 (530)	3.39 (86.1)	4.44 (112.8)	1.44 (36.6)
30CF6H-30-SOG			30					
30CF6H-56-SOG			56					
30CF9H-5-SOG	30,000 (2,070)	0.188 (4.8)	5	9HF	0.82 (530)	4.06 (103.1)	5.28 (134.1)	1.63 (41.3)
30CF9H-30-SOG			30					
30CF9H-56-SOG			56					

It is recommended that all fluids entering a high pressure system be thoroughly cleaned. Maximator filters are designed to remove small amounts of process particles. Pressure differential should not exceed 1000 psi across the filter elements. All dimensions for reference only and are subject to change.

All technical and dimensional information subject to change. All general Terms and Conditions of sale, including limitations of our liability, apply to all products and services sold.

Sour Gas Adapters and Couplings

» Adapters (male to female)

Adapters (male to female)

Maximator sour gas adapters and couplings are designed to join a variety of pressure connections where H₂S is present. All adapters are made of annealed 316 stainless steel material that meets NACE MR0175 specification.

» Instructions:

Find the male connection you want on the adapter in the „A“ column and the female connection of the adapter in the „B“ column. At the intersection of the two columns is the appropriate catalog number.



Tube Size in.	Male Connection A		Female Connection B		
	Connection Type	Maximum Pressure psi (bar)*	Female High Pressure / 30,000 pasi (2,070 bar)		
			1/4" 4H	3/8" 6H	9/16" 9H
Male High					
1/4	4H	30,000 (2,070)		30A4H6H-SOG	30A4H9H-SOG
3/8	6H	30,000 (2,070)	30A6H4H-SOG		30A6H9H-SOG
9/16	9H	30,000 (2,070)	30A9H4H-SOG	30A9H6H-SOG	
Male Pipe					
1/8	NPT	10,000 (700)	10A2P4H-SOG	10A2P6H-SOG	10A2P9H-SOG
1/4	NPT	10,000 (700)	10A4P4H-SOG	10A4P6H-SOG	10A4P9H-SOG
3/8	NPT	10,000 (700)	10A6P4H-SOG	10A6P6H-SOG	10A6P9H-SOG
1/2	NPT	10,000 (700)	10A8P4H-SOG	10A8P6H-SOG	10A8P9H-SOG
3/4	NPT	10,000 (700)	10A12P4H-SOG	10A12P6H-SOG	10A12P9H-SOG
1	NPT	10,000 (700)	10A16P4H-SOG	10A16P6H-SOG	10A16P9H-SOG
Male British Standard Pipe					
1/8	BSP	10,000 (700)	10A2B4H-SOG	10A2B6H-SOG	10A2B9H-SOG
1/4	BSP	10,000 (700)	10A4B4H-SOG	10A4B6H-SOG	10A4B9H-SOG
3/8	BSP	10,000 (700)	10A6B4H-SOG	10A6B6H-SOG	10A6B9H-SOG
1/2	BSP	10,000 (700)	10A8B4H-SOG	10A8B6H-SOG	10A8B9H-SOG
3/4	BSP	10,000 (700)	10A12B4H-SOG	10A12B6H-SOG	10A12B9H-SOG
1	BSP	10,000 (700)	10A16B4H-SOG	10A16B6H-SOG	10A16B9H-SOG

* The pressure rating of any adapter is the value of the lowest rated connection in the fitting.

Note: All Maximator adapters come standard in the "one-piece" design style. Adapters with the two piece design are available by adding a suffix -2P after the part numbers listed above. Both designs are identical in length, and are interchangeable with each other.

All technical and dimensional information subject to change. All general Terms and Conditions of sale, including limitations of our liability, apply to all products and services sold.

Pipe Valves & Fittings
to 15,200 psi (1,050 bar)

Products for Sour Gas Applications

Medium Pressure
to 22,500 psi (1,550 bar)

Adapters and Couplings

High Pressure
to 65,000 psi (4,500 bar)

Accessories

Ultra High Pressure
to 152,000 psi (10,500 bar)

Tools

Valve Actuators

Technical Information

Ball Valves
to 21,000 psi (1,500 bar)

Customized Solutions

Products for Sour Gas Applications
Pipe Valves & Fittings
to 15,200 psi (1,050 bar)

Adapters and Couplings
Medium Pressure
to 22,500 psi (1,550 bar)

Accessories
High Pressure
to 65,000 psi (4,500 bar)

Tools
Ultra High Pressure
to 152,000 psi (10,500 bar)

Technical Information
Valve Actuators

Customized Solutions
Ball Valves
to 21,000 psi (1,500 bar)

Tube Size in.	Male Connection A		Female Connection B Female Pipe / 10,000 psi (700 bar)					
	Connection Type	Maximum Pressure psi (bar)*	1/8" NPT	1/4" NPT	3/8" NPT	1/2" NPT	3/4" NPT	1" NPT
Male High								
1/4	4H	30,000 (2,070)	10A4H2P-SOG	10A4H4P-SOG	10A4H6P-SOG	10A4H8P-SOG	10A4H12P-SOG	10A4H16P-SOG
3/8	6H	30,000 (2,070)	10A6H2P-SOG	10A6H4P-SOG	10A6H6P-SOG	10A6H8P-SOG	10A6H12P-SOG	10A6H16P-SOG
9/16	9H	30,000 (2,070)	10A9H2P-SOG	10A9H4P-SOG	10A9H6P-SOG	10A9H8P-SOG	10A9H12P-SOG	10A9H16P-SOG

Tube Size in.	Male Connection A		Female Connection B Female British Standard Pipe / 10,000 psi (700 bar)					
	Connection Type	Maximum Pressure psi (bar)*	1/8" BSP	1/4" BSP	3/8" BSP	1/2" BSP	3/4" BSP	1" BSP
Male High								
1/4	4H	30,000 (2,070)	10A4H2B-SOG	10A4H4B-SOG	10A4H6B-SOG	10A4H8B-SOG	10A4H12B-SOG	10A4H16B-SOG
3/8	6H	30,000 (2,070)	10A6H2B-SOG	10A6H4B-SOG	10A6H6B-SOG	10A6H8B-SOG	10A6H12B-SOG	10A6H16B-SOG
9/16	9H	30,000 (2,070)	10A6H2B-SOG	10A6H4B-SOG	10A6H6B-SOG	10A6H8B-SOG	10A6H12B-SOG	10A6H16B-SOG

* The pressure rating of any adapter is the value of the lowest rated connection in the fitting.

Sour Gas Adapters and Couplings

» Couplings (female to female)

Couplings (female to female)

Maximator sour gas adapters and couplings are designed to join a variety of pressure connections where H₂S is present. All adapters are made of annealed 316 stainless steel material that meets NACE MR0175 specification.



Female Connection A			Female Connection B		
Tube Size in.	Connection Type	Maximum Pressure psi (bar)*	Female High Pressure / 30,000 psi (2,070 bar)		
			1/4" 4H	3/8" 6H	9/16" 9H
Female High					
1/4	4H	30,000 (2,070)	30F4H-SOG	30F4H6H-SOG	30F4H9H-SOG
3/8	6H	30,000 (2,070)		30F6H-SOG	30F6H9H-SOG
9/16	9H	30,000 (2,070)			30F9H-SOG

Female Connection A			Female Connection B					
Tube Size in.	Connection Type	Maximum Pressure psi (bar)*	Female Pipe / 10,000 psi (700 bar)					
			1/8" NPT	1/4" NPT	3/8" NPT	1/2" NPT	3/4" NPT	1" NPT
Female High								
1/4	4H	30,000 (2,070)	10F4H2P-SOG	10F4H4P-SOG	10F4H6P-SOG	10F4H8P-SOG	10F4H12P-SOG	10F4H16P-SOG
3/8	6H	30,000 (2,070)	10F6H2P-SOG	10F6H4P-SOG	10F6H6P-SOG	10F6H8P-SOG	10F6H12P-SOG	10F6H16P-SOG
9/16	9H	30,000 (2,070)	10F9H2P-SOG	10F9H4P-SOG	10F9H6P-SOG	10F9H8P-SOG	10F9H12P-SOG	10F9H16P-SOG

Female Connection A			Female Connection B					
Tube Size in.	Connection Type	Maximum Pressure psi (bar)*	Female British Standard Pipe / 10,000 psi (700 bar)					
			1/8" BSP	1/4" BSP	3/8" BSP	1/2" BSP	3/4" BSP	1" BSP
Female High								
1/4	4H	30,000 (2,070)	10F4H2B-SOG	10F4H4B-SOG	10F4H6B-SOG	10F4H8B-SOG	10F4H12B-SOG	10F4H16B-SOG
3/8	6H	30,000 (2,070)	10F6H2B-SOG	10F6H4B-SOG	10F6H6B-SOG	10F6H8B-SOG	10F6H12B-SOG	10F6H16B-SOG
9/16	9H	30,000 (2,070)	10F9H2B-SOG	10F9H4B-SOG	10F9H6B-SOG	10F9H8B-SOG	10F9H12B-SOG	10F9H16B-SOG

* The pressure rating of any adapter is the value of the lowest rated connection in the fitting.

All technical and dimensional information subject to change. All general Terms and Conditions of sale, including limitations of our liability, apply to all products and services sold.

Products for Sour Gas Applications
Pipe Valves & Fittings
to 15,200 psi (1,050 bar)

Adapters and Couplings
Medium Pressure
to 22,500 psi (1,550 bar)

Accessories
High Pressure
to 65,000 psi (4,500 bar)

Tools
Ultra High Pressure
to 152,000 psi (10,500 bar)

Technical Information
Valve Actuators

Customized Solutions
Ball Valves
to 21,000 psi (1,500 bar)

Adapters (male to male)

Maximator male to male adapters allow the joining of two different sizes and /or type of tube or pipe female connections.



Tube Size in.	Male Connection A		Male Connection B Male High Pressure / 30,000 psi (2,070 bar)		
	Connection Type	Maximum Pressure psi (bar)*	1/4" 4H	3/8" 6H	9/16" 9H
Female High					
1/4	4H	30,000 (2,070)	30M4H-SOG	30M4H6H-SOG	30M4H9H-SOG
3/8	6H	30,000 (2,070)		30M6H-SOG	30M6H9H-SOG
9/16	9H	30,000 (2,070)			30M9H-SOG

Tube Size in.	Male Connection A		Male Connection B Male Pipe / 10,000 psi (700 bar)					
	Connection Type	Maximum Pressure psi (bar)*	1/8" NPT	1/4" NPT	3/8" NPT	1/2" NPT	3/4" NPT	1" NPT
Female High								
1/4	4H	30,000 (2,070)	10M4H2P-SOG	10M4H4P-SOG	10M4H6P-SOG	10M4H8P-SOG	10M4H12P-SOG	10M4H16P-SOG
3/8	6H	30,000 (2,070)	10M6H2P-SOG	10M6H4P-SOG	10M6H6P-SOG	10M6H8P-SOG	10M6H12P-SOG	10M6H16P-SOG
9/16	9H	30,000 (2,070)	10M9H2P-SOG	10M9H4P-SOG	10M9H6P-SOG	10M9H8P-SOG	10M9H12P-SOG	10M9H16P-SOG

Tube Size in.	Male Connection A		Male Connection B Male British Standard Pipe / 10,000 psi (700 bar)					
	Connection Type	Maximum Pressure psi (bar)*	1/8" BSP	1/4" BSP	3/8" BSP	1/2" BSP	3/4" BSP	1" BSP
Female High								
1/4	4H	30,000 (2,070)	10M4H2B-SOG	10M4H4B-SOG	10M4H6B-SOG	10M4H8B-SOG	10M4H12B-SOG	10M4H16B-SOG
3/8	6H	30,000 (2,070)	10M6H2B-SOG	10M6H4B-SOG	10M6H6B-SOG	10M6H8B-SOG	10M6H12B-SOG	10M6H16B-SOG
9/16	9H	30,000 (2,070)	10M9H2B-SOG	10M9H4B-SOG	10M9H6B-SOG	10M9H8B-SOG	10M9H12B-SOG	10M9H16B-SOG

* The pressure rating of any adapter is the value of the lowest rated connection in the fitting.

All technical and dimensional information subject to change. All general Terms and Conditions of sale, including limitations of our liability, apply to all products and services sold.

High Pressure Tubing for Sour Gas Applications

» Pressures to 30,000 psi (2,070 bar)

Sour Gas Tubing

Maximator Sour Gas Tubing is designed for oil and gas services where H₂S is present. All tubing is seamless annealed 316 stainless steel material in compliance with NACE MR0175. This tubing is made under strict manufacturing and quality control standards and inspections, with dimensional tolerances to match the requirements of the high pressure coned and threaded connections.



Tubing Tolerances

Normal Tubing Size in. (mm)	Tolerance O.D. in. (mm)
1/4 (6.35)	0.248 / 0.243 (6.299 / 6.172)
3/8 (9.53)	0.370 / 0.365 (9.398 / 9.271)
9/16 (14.29)	0.557 / 0.552 (14.147 / 14.021)

Catalog Number	Tube Material	Fits Connection Type	Tube Size in. (mm)		Working Pressure psi (bar)				
			O.D.	I.D.	-325°F to 100°F (-198°C to 37°C)	200°F (93°C)	400°F (204°C)	600°F (315°C)	800°F (426°C)
30TU4H-316-SOG	316SS	4HF	1/4 (6.35)	0.083 (2.11)	30,000 (2,070)	27,000 (1,850)	24,900 (1,700)	22,800 (1,600)	21,600 (1,500)
30TU6H-316-SOG	316SS	6HF	3/8 (9.53)	0.125 (3.20)	30,000 (2,070)	27,000 (1,850)	24,900 (1,700)	22,800 (1,600)	21,600 (1,500)
30TU9H-316-SOG	316SS	9HF	9/16 (14.29)	0.188 (4.77)	30,000 (2,070)	27,000 (1,850)	24,900 (1,700)	22,800 (1,600)	21,600 (1,500)

All dimensions for reference only and are subject of change.

All technical and dimensional information subject to change. All general Terms and Conditions of sale, including limitations of our liability, apply to all products and services sold.

Products for Sour Gas Applications
Pipe Valves & Fittings
to 15,200 psi (1,050 bar)

Adapters and Couplings
Medium Pressure
to 22,500 psi (1,550 bar)

Accessories
High Pressure
to 65,000 psi (4,500 bar)

Tools
Ultra High Pressure
to 152,000 psi (10,500 bar)

Technical Information
Valve Actuators

Customized Solutions
Ball Valves
to 21,000 psi (1,500 bar)

Coned and threaded nipples

Maximator offers a line of coned and threaded ultra high pressure tube nipples in a variety of lengths for all standard tube sizes.

The coned and threaded ultra high pressure tube nipples are available in 316 stainless steel. See chart below for ordering information.

Special length coned and threaded nipples are available upon request. Consult Maximator for availability and price.



Catalog Numbers are 316 Stainless Steel material							Fits Connection Type	Tube Size in. (mm)		Working Pressure at 100°F psi (mm)
Length in. (mm)								O.D.	I.D.	
2.75" (69.85)	3" (76.2)	4" (101.6)	6" (152.4)	8" (203.2)	10" (254)	12" (304.8)				
30N4H-2.75-316-SOG	30N4H-3-316-SOG	30N4H-4-316-SOG	30N4H-6-316-SOG	30N4H-8-316-SOG	30N4H-10-316-SOG	30N4H-12-316-SOG	4HF	1/4	0.083 (2.11)	30,000 (2,070)
	30N6H-3-316-SOG	30N6H-4-316-SOG	30N6H-6-316-SOG	30N6H-8-316-SOG	30N6H-10-316-SOG	30N6H-12-316-SOG	6HF	3/8	0.125 (3.17)	30,000 (2,070)
		30N9H-4-316-SOG	30N9H-6-316-SOG	30N9H-8-316-SOG	30N9H-10-316-SOG	30N9H-12-316-SOG	9HF	9/16	0.188 (4.77)	30,000 (2,070)

Standard nipples are not supplied with glands and collars, see Fittings on page 6 for these components. See adjacent Tubing page 14, for pressure/temperature rating chart.

All dimensions are for reference only and subject to change.