

✓ **Applications**

Range of Dead weight tester is designed to test, adjust and calibrate measuring instruments, mechanical or electronic pressure by comparison (pressure gauges, pressure transmitters or sensors or switches)

They consist of a pressure generator, a piston/cylinder unit, a set of weigh identified. The capstan is used to generate a pressure pushing the fluid through the piston. This pressure is balanced by the piston/cylinder assembly which allows to compare the instrument to be calibrated to the pressure values generated by the standard. These scales are intended for the calibration gauge.

The Dead weight are robust and easy to use and have a high long-term stability.

✓ **Technical specifications**

- Calibration :	It is necessary to recalculate the pressure generated by the dead weight according to the different variables. Our dead weight are calibrated in the following terms of use : Temperature 20°C - Pressure atmos. 1013.25 hPa - Humidity 50% - acceleration 9.80665 m/s ²
- Fluid :	Mineral or synthetic oil depending on model, colorless, compatible with medical or food uses – tank volume 125 cm ³
- Check/adjust the seat :	leveling bubble and adjustable feet
- Connection for the instrument to be tested :	swivel G1/2 standard
- Rotating weigh :	Training masses : manual rotation
- Carter :	Light alloy aluminium AG3 + high-resistance paint
- Ratchet :	removable for transport
- Piston/cylinder :	Single or twin piston tungsten carbide and/or treated steel - Repeatability : 5.10 ⁻⁵ - Sensitivity : 2.10 ⁻⁵ - Precision dead weight : 10 ⁻⁴
- Weight :	stainless steel - Weight of the set of weights from 25 kg to 100 kg depending on model – Shape masses ergonomic, easy loading of the masses on the bell - Marking corresponding with the measuring unit (bar, mbar, KPa, PSI etc..)

✓ **Specific Model**

- Model :	BH2-4000B - dead weight single piston
- Measuring range :	40 to 4000 bar / 600 to 60000 PSI / 4000 to 400000 kPa
- Accuracy dead weight:	0.004 + (4.10 ⁻⁴ x P) (with P in bar)
- Weight dead weight without masses :	18 kg
- Fluid :	Oil Sebacate - fluid density : 915 kg/m ³
- Typical cross-section of the piston :	1.96315 mm ²
- Material piston/cylinder :	tungsten carbide
- Number of piston :	1

✓ **Divers**

- **Manuel** : a detailed operating instructions supplied with the device + Certificate + 0.5 liter Oil
- **Maintenance** : Our technical department is at your disposition for the revision, calibration or service your unit – Calibration device recommended every 2 years.

✓ **Dimensions of device**

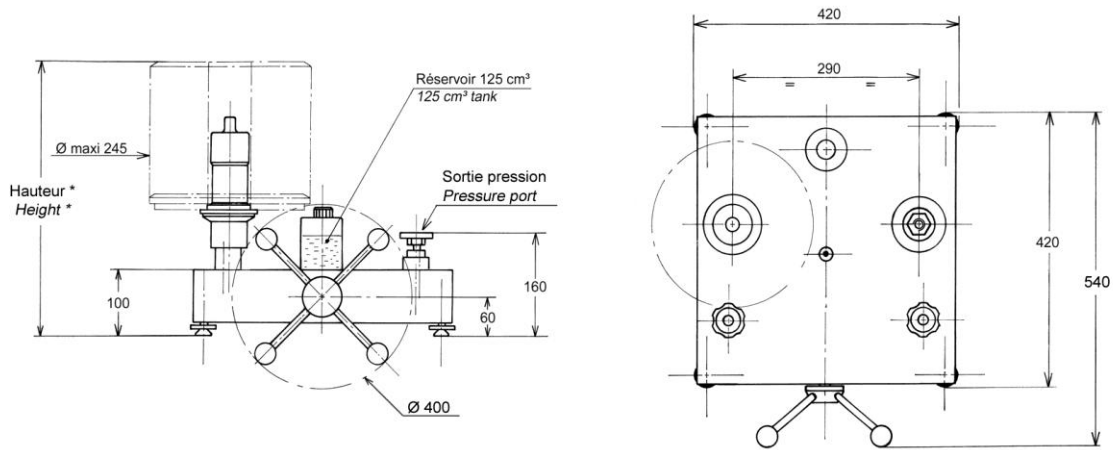

Height with standard set of weight : (bar, KPa) : 500 mm (PSI) : 490 mm

Unit used : mm

✓ **Standard weight sets and intermediate**

Standard set			
Unit : BAR (Ref. MB0053)	Pressure (bar)	Total weight	Typical value (g)
	400	8	8000
	360	1	7200
	200	1	4000
	80	2	1600
	40	1	800
	20	1	400
	10	1	200
Pressure Weight bell	40		800
TOTAL	4030	15	±81 kg

Intermediate set			
BAR (Ref. MB0054)	Pressure (bar)	Total weight	Typical value (g)
	8	1	160
	4	1	80
	2	1	40
	0.8	2	16
	0.4	1	8
	0.2	1	4
TOTAL	16.2	7	324 g

Standard set			
Unit : PSI (Ref. MB0058)	Pressure (PSI)	Total weight	Typical value (g)
	4000	13	5520
	3400	1	4968
	2000	1	2760
	800	2	1104
	400	1	552
	200	1	276
	Pressure Weight bell	600	
TOTAL	60200	19	±85 kg

Intermediate set			
PSI (Ref. MB0059)	Pressure (PSI)	Total weight	Typical value (g)
	80	2	110.4
	40	1	55.2
	20	1	27.6
	8	2	11
	4	1	5.5
	2	1	2.75
TOTAL	242	8	333.85 g

Standard set				
Unit : kPa	Pressure (Kpa)	Total weight	Typical value (g)	
	40000	8	8000	
	36000	1	7200	
	20000	1	4000	
	8000	2	1600	
	4000	1	800	
	2000	1	400	
	1000	1	200	
	Pressure Weight bell	4000		800
	TOTAL	403000	15	±81 kg

Intermediate set			
kPa	Pressure (Kpa)	Total weight	Typical value (g)
	800	1	160
	400	1	80
	200	1	16
	80	2	8
	40	1	4
	20	1	2
TOTAL	1620	7	324 g

✓ **Options for weight set**



transport metal boxes

(OP0101) : 260 x 260 x 310 mm - weight empty : 6 kg

Suitcase for post planning and transportation

(OP0095) small : 280 x 250 x 280 mm - weight empty : 5 kg

(OP0099) large : 500 x 350 x 280 mm - weight empty : 11 kg

Useful for BH2-4000B : Consult us !

✓ **Options**

- Intermediate weight set or Standard weight set additional for different units
- Adjust the dead weight with a different acceleration of 9.80665 m/s^2 on request
- Calibration of the instrument : Points statement AREMECA or certificate of calibration DAkKS or COFRAC
- Tin oil : 1 liter, 2 liters or 5 liters of oil
- Motorization kit / visualization

✓ **Transport and packaging**

- **Packaging** : woodpack is provided for the shipping

Designation/Reference	Dimension / carton or shipping crate	Weight empty / total weight (packaging + materiel)
Dead weight without weight	470 x 470 x 240 mm	Carton empty 1.5 kg Total weight ± 20 kg
Standard weight set	300 x 300 x 170 mm	Carton empty 1.5 kg Total weight ± 88 kg
Wood packaging SB0002	790 x 480 x 340 mm	Suitcase empty 20 kg Total weight ± 130 kg (dead weight + weight set + packaging)



SB0002

- **Note** : shipping is extra.

✓ **Other models available in the range BH2**

(Datasheet is available on request)

Models single piston

Models	Accuracy	Measuring range		
		Bar ou kg/cm ²	PSI	kPa
BH2-5000B	10 ⁻⁴	40 to 5000	600 to 72500	4000 to 500000
BH2-3000B	10 ⁻⁴	40 to 3000	600 to 44000	4000 to 300000
BH2-2500B	10 ⁻⁴	40 to 2500	600 to 36200	4000 to 250000
BH2-2000B	10 ⁻⁴	40 to 2000	600 to 30000	4000 to 200000
BH2-1200B sp	10 ⁻⁴	2 to 1200	30 to 16000	200 to 120000
BH2-600B sp	10 ⁻⁴	2 to 600	30 to 10000	200 to 60000
BH2-300B sp	10 ⁻⁴	1 to 300	15 to 4000	100 to 30000
BH2-150B	10 ⁻⁴	0.5 to 150	10 to 2000	50 to 15000
BH2-60B	10 ⁻⁴	0.2 to 60	3 to 800	20 to 6000
BH2-30B	10 ⁻⁴	0.1 to 30	2 to 400	10 to 3000

Dual piston models : these dead weight tester integrating two pistons can get two ranges from a single set of weight

Models	Accuracy	Measuring range		
		Bar ou kg/cm ²	PSI	kPa
BH2-1200B dp	10 ⁻⁴	1 to 60 + 20 to 1200	10 to 800 + 200 to 16000	100 to 6000 2000 to 120000
BH2-600B dp	10 ⁻⁴	1 to 60 + 10 to 600	10 to 800 + 100 to 8000	100 to 6000 1000 to 60000
BH2-300B dp	10 ⁻⁴	1 to 60 + 5 to 300	10 to 800 + 50 to 4000	100 to 6000 500 to 30000

✓ **Accessories** (Ask for our specific documentation)

- Accessory case (ref.OP0057)
- Setting gauge kit (ref.OP0125)
- Separator all fluids up to 800 bar (ref.OP0023)
- Case connectors M (ref.OP0174) – Case connectors G (ref.OP0171) - Case connectors NPT (ref.OP0172) - Case connectors BSP-TR (ref.OP0173) - Case with 17 connectors M + G + NPT + BSP-TR (ref.OP0037) – unit connector (consult us)
- Kit drain tank (ref.OP0025)
- Bench cleaning (ref.OP0062)
- Carrying case (ref.OP0002)